

General Purpose Relay

SZR-LY series

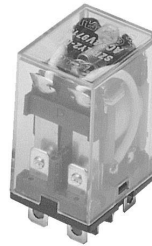
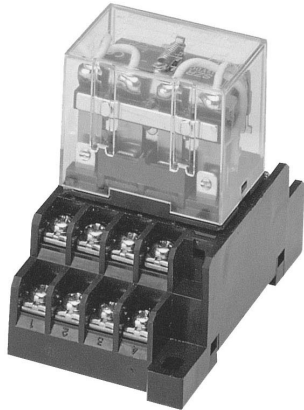

FEATURES

- A wide range of applications from power to sequence control
- Designed small, general purpose 10A relay
- Arc barrier equipped
- High contact deposition resistance with (Ag-CdO) contact
- High dielectric strength of 1,800VAC
- High vibration and shock resistance
- Contains LED for output indicator
- Contains a diode to absorb counter electromotive voltage
- UL, CE approved

DESCRIPTION

SZR-LY series general purpose power relays are designed for general purpose and a wide range of applications from power to sequence controls in various factory machines and control panels.

These relays break 10A loads and ideal for electric control panels which require stable and reliable relays.

One standard type and three special types are available – LED self-contained, diode self-contained and LED & diode self-contained. These options allow the customers to select the appropriate model based on their needs.

A rapid response and excellent support is ensured via Honeywell's global sales and distribution channels.

APPLICATIONS

- Control Panels
- Elevator Panels
- Machine tools
- Test equipment

WARNINGS



- DO NOT USE this product as safety or emergency devices or in any other applications where failure of the product could result in a personal injury
- This information presented in this product sheet is for reference only. DO NOT USE this document as product installation information.

MODEL SELECTION GUIDE

■ Relay

Type	Terminal	Contact	Catalog Listing
Standard	Plug-in/Solder	DPDT	SZR-LY2-1
		4PDT	SZR-LY4-1
	PCB	DPDT	SZR-LY2-1P
		4PDT	SZR-LY4-1P
LED Indicator	Plug-in/Solder	DPDT	SZR-LY2-N1
DIODE surge suppression		4PDT	SZR-LY4-N1
		DPDT	SZR-LY2-D1
LED Indicator + DIODE surge suppression		4PDT	SZR-LY4-D1
		DPDT	SZR-LY2-X1
		4PDT	SZR-LY4-X1

Select the catalog listing and specify the needed coil voltage rating[e.g., SZR-LY2-N1 AC110V]

■ Socket

Relay Contact \ Mounting	Track mounting	Solder terminal	PCB terminal
DPDT	SZX-SLF-08N	SZX-SLB-08	SZX-SLB-08P
4PDT	SZX-SLF-14	SZX-SLB-14	SZX-SLB-14P

TECHNICAL INFORMATION

■ Contact Ratings

Rating \ Load	Resistive load (p.f.=1)	Inductive load (p.f.=0.4, L/R=7ms)
Rated load	AC110V 10A, DC24V 10A	AC110V 7.5A, DC24V 5A
Carry current	10A	
Max. operating voltage	AC 250V DC 125V	
Max. operating current	10A	
Max. switching capacity	1,100VA 240W	825VA 120W
Min. permissible load	DC5V 100mA	

General Purpose Relay

SZR-LY series

■ Coil Ratings

(DPDT)

Item Rated voltage (V)		Rated current (mA)		Coil resistance (Ω)	Coil inductance (H)		Pick-up voltage (V)	Dropout voltage (V)	Maximum voltage (V)	Power consumption (W)
		50 Hz	60 Hz		Armature OFF	Armature ON				
AC	6	214.1	183	12.2	0.04	0.08	Max. 80%	Min. 30%	110%	Approx. 1.0 to 1.2 (60Hz)
	12	106.5	91	46	0.17	0.33				
	24	53.8	46	180	0.69	1.3				
	50	25.7	22	788	3.22	5.66				
	100/110	11.7/12.9	10/11	3,750	14.54	24.6				
	110/120	9.9/10.8	8.4/9.2	4,430	19.2	32.1				
	200/220	6.2/6.8	5.3/5.8	12,950	54.75	94.07				
220/240	4.8/5.3	4.2/4.6	18,790	83.5	136.4					
DC	6	150		40	0.17	0.33	Max. 80%	Min. 10%	110%	Approx. 0.9
	12	75		160	0.73	1.37				
	24	36.9		650	3.2	5.72				
	48	18.5		2,600	10.6	21.0				
	100/110	9.1/10		11,000	45.6	86.2				

(4PDT)

Item Rated voltage (V)		Rated current (mA)		Coil resistance (Ω)	Coil inductance (H)		Pick-up voltage (V)	Dropout voltage (V)	Maximum voltage (V)	Power consumption (W)
		50 Hz	60 Hz		Armature OFF	Armature ON				
AC	6	386	330	5	0.02	0.04	Max. 80%	Min. 30%	110%	Approx. 1.95 ~ 2.5 (60Hz)
	12	199	170	20	0.1	0.17				
	24	93.6	80	78	0.38	0.67				
	50	46.8	40	350	1.74	2.88				
	100/110	22.5/25.5	19/21.8	1,800	10.5	17.3				
200/220	11.5/13.1	9.8/11.2	6,700	33.1	57.9					
DC	6	240		25	0.09	0.21	Max. 80%	Min. 10%	110%	Approx. 1.5
	12	120		100	0.39	0.84				
	24	69		350	1.41	2.91				
	48	30		1,600	6.39	13.6				
	100/110	15/15.9		6,900	32	63.7				

- Note: 1. The rated current and coil resistance are measured at a coil temperature of 23°C with tolerances of +15%, -20% for AC rated current and ± 15% for DC coil resistance.
 2. The rated current of N1 and X1 type is 4mA higher than the value in the table above.

■ Specifications

Contact material		AgCdO
Contact resistance		Max. 50 mΩ
Operate time		Max. 25 ms
Release time		Max. 25 ms
Operating frequency	Mechanical	18,000 operations/hour
	Electrical	1,800 operations/hour
Insulation resistance		Min. 100 MΩ at 500 VDC
Dielectric withstand voltage		AC 1,800V 50/60 Hz for 1 minute between non-continuous current carrying terminals and between coil terminals and contact terminals AC 1,000V 50/60 Hz for 1 minute between contacts of same polarity
Vibration resistance	Mechanical durability	10~55 Hz at double amplitude of 1.0 mm
	Malfunction durability	10~55 Hz at double amplitude of 1.0 mm
Shock resistance	Mechanical durability	1,000 m/s ² (Approx. 100G)
	Malfunction durability	200 m/s ² (Approx. 20G)
Service life	Mechanical	AC : Min. 50million operations (at operating frequency of 18,000 operations/hour) DC : Min. 100million operations (at operating frequency of 18,000 operations/hour)
	Electrical	DPDT : Min. 500,000 operations (at operating frequency of 1,800 operations/hour) 4PDT : Min. 200,000 operations (at operating frequency of 1,800 operations/hour)
Weight		DPDT: Approx. 35g 4PDT: Approx. 65g

Note : The data shown above are of initial value

General Purpose Relay

SZR-LY series

Characteristic Data

DPDT

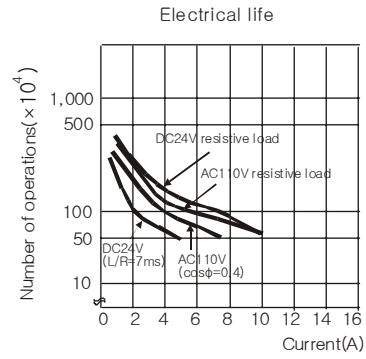
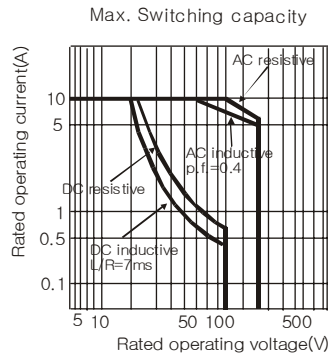

4PDT

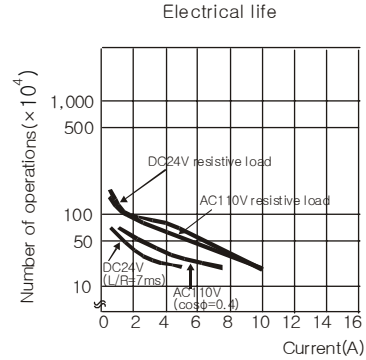
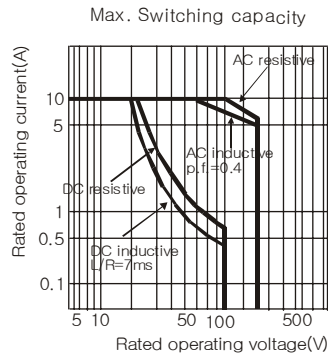

Dimension, circuit diagram, terminal arrangement and mounting hole

– Relays

SZR-LY2-1
SZR-LY2-N1
SZR-LY2-D1
SZR-LY2-X1

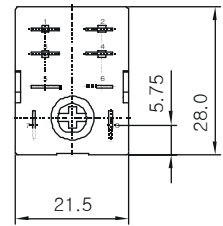
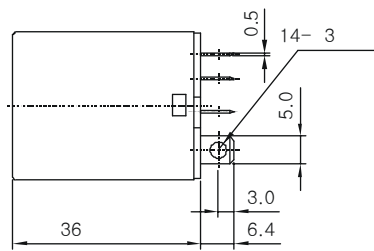
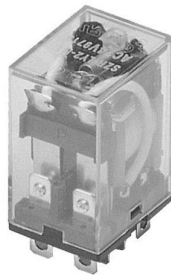

LY2-1

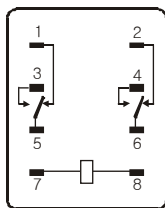

LY2-N1 AC

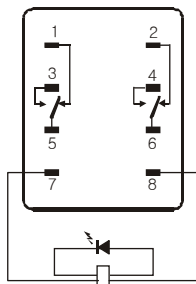

LY2-N1 DC

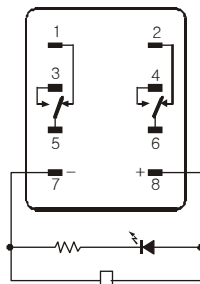

LY2-D1

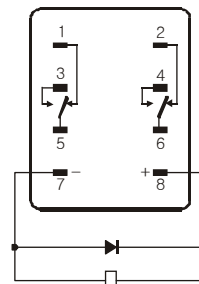

LY2-X1

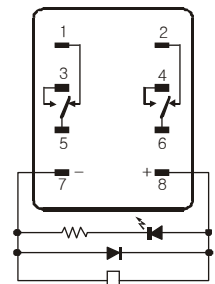

<bottom view>

General Purpose Relay

SZR-LY series

SZR-LY4-1
 SZR-LY4-N1
 SZR-LY4-D1
 SZR-LY4-X1

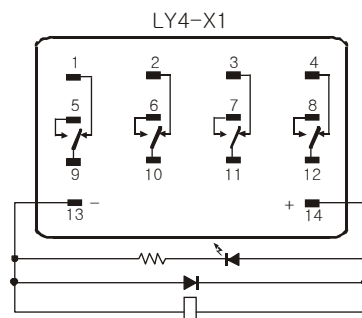
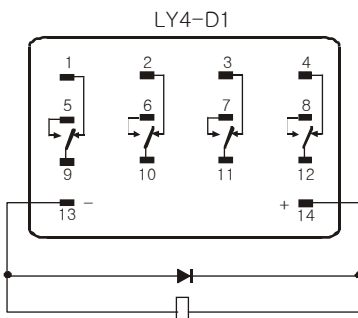
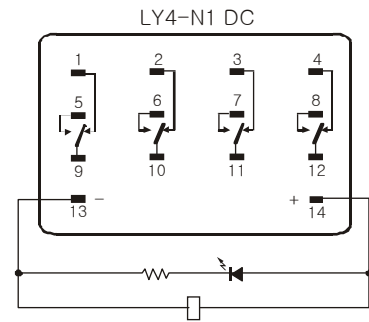
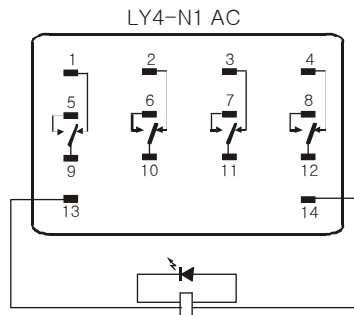
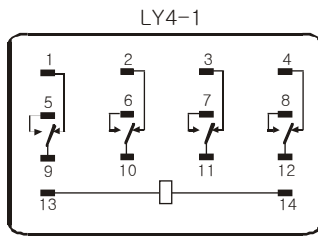
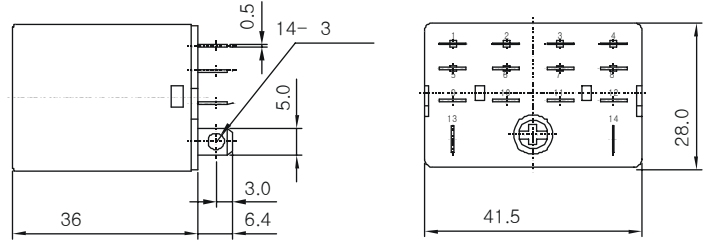

<bottom view>

SZR-LY2-1P
 SZR-LY4-1P

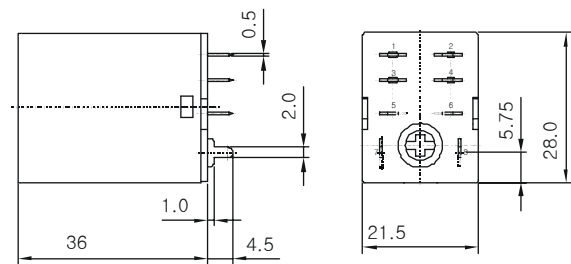

DPDT

4PDT

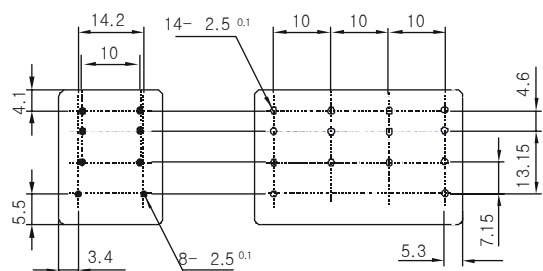

Note: The circuit diagram is same with standard type of SZR-LY2-1 / SZR-LY4-1

General Purpose Relay

SZR-LY series

– Socket

SZX-SLF-08N

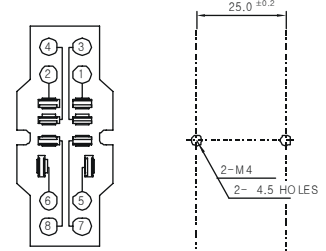
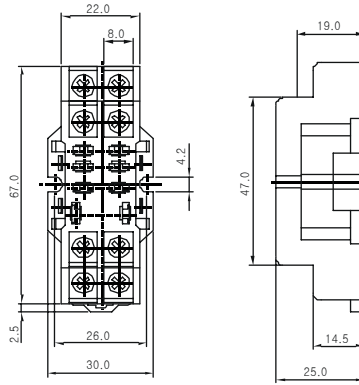

SZX-SLF-14

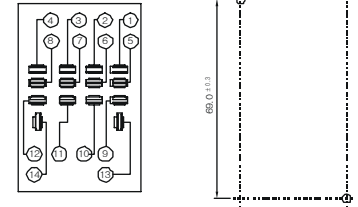
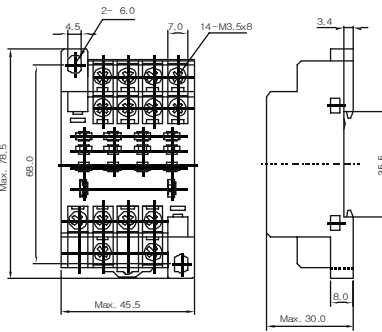

SZX-SLB-08

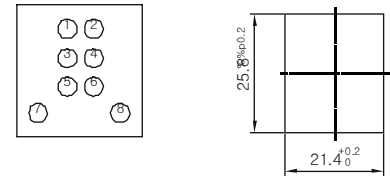
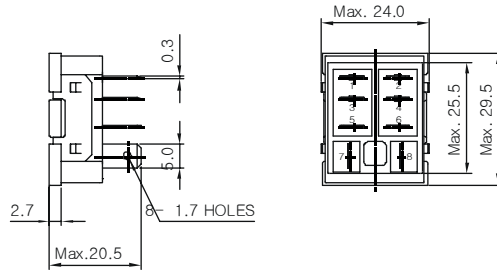

SZX-SLB-14

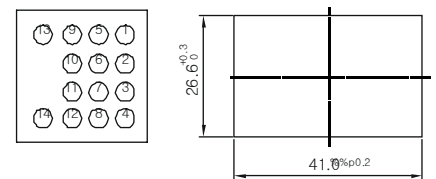
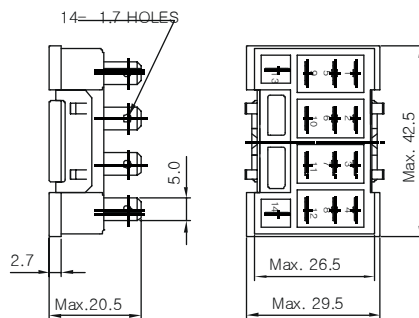

General Purpose Relay

SZR-LY series

SZX-SLB-08P

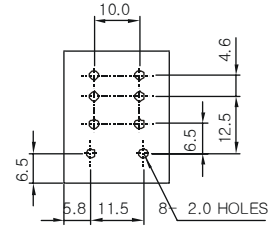
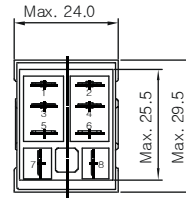
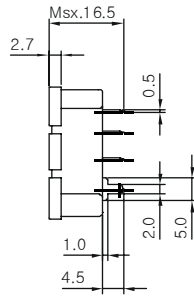

SZX-SLB-14P

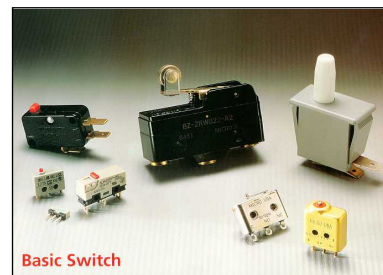
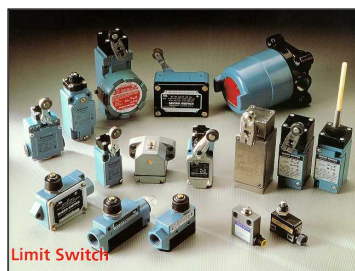
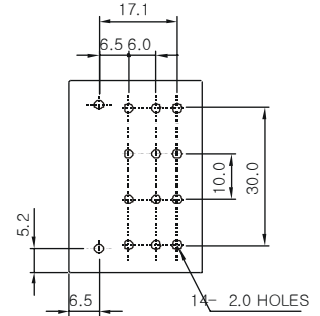
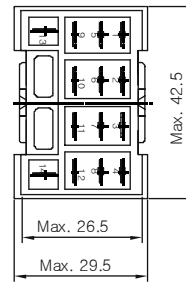
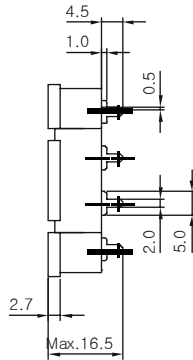

In addition to the SZR-LY series, Honeywell offers one of the industry's widest range of components to meet virtually any application requirement. Please contact your local Honeywell office for more information.

General Purpose Relay

SZR-LY series

Warranty/Remedy

Honeywell warrants goods of its manufacture as being free of defective material and faulty workmanship. Contact your local sales office for warranty information. If warranted goods are returned to Honeywell during that period of coverage, Honeywell will repair or replace without charge those items it finds defective. The foregoing is Buyer's sole remedy and **is in lieu of all other warranties, expressed or implied, including those of merchantability and fitness for a particular purpose.**

While we provide application assistance, personally and through our literature, it is up to the customer to determine the suitability of the product in the application.

Specifications may change at any time without notice. The information we supply is believed to be accurate and reliable as of this printing. However, we assume no responsibility for its use.

Sales and Service

Honeywell serves its customers through a worldwide network of sales offices and distributors. For application assistance, current specifications, pricing, or name of the nearest Authorized Distributor, contact your local sales office or:

INTERNET: www.honeywell.com/sensing

E-mail: info.sc@honeywell.com

ASIA PACIFIC

**Sensing and Control
Asia Pacific Headquarters**
Phone: +(65)355-2828
Fax: +(65)445-3033

Australia
Honeywell Limited
Phone: +(61)2-9370-4500
Fax: +(61)2-9370-4525
Toll Free 1300-36-39-36
Toll Free Fax: 1300-36-04-70

China — PRC — Beijing
Honeywell China Inc.
Phone: +(86-10)6561-0208
Ext.205
Fax: +(86-10)6561-0618

China — PRC — Shanghai
Honeywell China Inc.
Phone: +(86-21)6534-9181
Fax: +(86-21)6534-2248

China — Hong Kong S.A.R.
Honeywell Ltd.
Phone: +(852)2331-9133
Fax: +(852)2331-9998

China — PRC — Chengdu
Honeywell China Inc.
Phone: +(86-28)6786-348
Fax: +(86-28)6787-061

China — PRC — Guangzhou
Honeywell China Inc.
Phone: +(86-20)3879-1169
Fax: +(86-20)3879-1269

China — PRC — Shenzhen
Honeywell China Inc.
Phone: +(86)755-518-1226
Fax: +(86)755-518-1221

Indonesia
Honeywell Indonesia Pte Ltd.
Phone: +(6221)521-3330
Fax: +(6221)521-3735

India

TATA Honeywell Ltd.
Phone: +(91)20 6875-6875-534
Fax: +(91)20 6875-992

Japan

Honeywell Inc
Phone: +(81)3 5440 1395
Fax: +(81)3 5440 1314

South Korea

Honeywell Korea Co Ltd.
Phone: +(82)799-6114
Fax: +(82)792-9011

Malaysia

Honeywell Engineering Sdn
Bhd.
Phone: +(603)7958-4988
Fax: +(603)7958-8922

New Zealand

Honeywell Limited
Phone: +(649)623-5050
Fax: +(649)623-5060
Toll Free 0800-202-088

Philippines

Honeywell Systems
(Philippines) Inc.
Phone: +(632)636-1649
Fax: +(632)636-1650

Singapore

Honeywell South East Asia
Phone: +(65)355-2828
Fax: +(65)445-3033

Thailand

Honeywell Systems
(Thailand) Ltd.
Phone: +(662)693-3099
Fax: +(662)693-3085

Taiwan R.O.C.

Honeywell Taiwan Ltd.
Phone: +(8862)2245-1000
Fax: +(8862)2245-3242

EUROPE

Austria

Honeywell Austria GmbH.
Phone: +(43)1 727 80 366/246
Fax: +(43)1 727 80 337

Belgium

Honeywell SANV
Phone: +(32)2 728 2522
Fax: +(32)2 728 2502

Bulgaria

Honeywell EOOD
Phone: +(359)2 79 40 27
Fax: +(359)2 79 40 90

Czech Republic

Honeywell spol.s.r.o.
Phone: +(420)2 6112 6112
Fax: +(420)2 6112 3461

Denmark

Honeywell A/S
Phone: +(45)39 55 55 55
Fax: +(45)39 55 55 58

Finland

Honeywell OY
Phone: +(358)9 3480101
Fax: +(358)9 34801375

France

Honeywell SA
Phone: +(33)1 60 19 82 68
Fax: +(33)1 60 19 81 73

Germany

Honeywell AG
Phone: +(49)69 8064 444
Fax: +(49)69 8064 442

Hungary

Honeywell Kft.
Phone: +(361)451 4300
Fax: +(361)451 4343

Italy

Honeywell S.p.A.
Phone: +(39)02 92146 450/
456
Fax: +(39)02 92146 490

The Netherlands

Honeywell B.V.
Phone: +(31)20 565 69 11
Fax: +(31)20 565 66 00

Norway

Honeywell A/S
Phone: +(47)66 76 20 00
Fax: +(47)66 76 20 90

Poland

Honeywell Sp.zo.o
Phone: +(48)22 606 0900
Fax: +(48)22 606 0901

Portugal

Honeywell Portugal Lda.
Phone: +(351 21)424 50 00
Fax: +(351 21)424 50 99

Romania

Honeywell Bucharest
Phone: +(40)1 2110076
Fax: +(40)1 2103375

Commonwealth of Independent States (CIS)

Z.A.O. Honeywell
Phone: +(7 095)796 98 36
Fax: +(7 095)796 98 93

Slovak Republic

Honeywell s.r.o.
Phone: +(421 7)58247 403
/400
Fax: +(421 7)58247 415

South Africa (Republic of)

Honeywell Southern Africa
Honeywell S.A. Pty. Ltd.
Phone: +(27)11 805 1211
Fax: +(27)11 805 1354

Spain

Honeywell S.A.
Phone: +(34)91 313 6100
Fax: +(34)91 313 6129

Sweden

Honeywell AB
Phone: +(46)8 775 55 00
Fax: +(46)8 775 56 00

Switzerland

Honeywell AG.
Phone: +(41)1 855 24 70
Fax: +(41)1 855 24 45

Turkey

Honeywell Turkey A.S.
Phone: +(90)216 464 4764
Fax: +(90)216 464 4794

United Kingdom

Honeywell Control Systems
Ltd.
Phone: +(44)118 906 2600
Fax: +(44)118 981 7513

Mediterranean & African Distributors

Honeywell SpA
Phone: +(39)2 921 46 232
Fax: +(39)2 921 46 233

Middle East Headquarters

Honeywell Middle East Ltd.
Phone: +(9712)443 2119
Fax: +(9712)443 2536

NORTH AMERICA

Canada

Honeywell LTD.
Phone: 1-800-737-3360
Fax: 1-800-565-4130

USA

Honeywell
Sensing and Control,
International Headquarters
Phone: 1-800-537-6945
1-815-235-6847
Fax: 1-815-235-6545
E-mail: info.sc@honeywell.com

LATIN AMERICA

Argentina

Honeywell S.A.I.C.
Phone: +(54 11)4383-3637
Fax: +(54 11)4325-6470

Brazil

Honeywell do Brasil & Cia
Phone: +(55 11)7266-1900
Fax: +(55 11)7266-1905

Chile

Honeywell Chile, S.A.
Phone: +(56 2)233-0688
Fax: +(56 2)231-6679

Columbia

Honeywell Columbia, S.A.
Phone: +(57 1)623-3239/3051
Fax: +(57 1)623-3395

Ecuador

Honeywell S.A.
Phone: +(593 2)981-560/1
Fax: +(593 2)981-562

Mexico

Honeywell S.A. de C.V.
Phone: +(52 5)259 1966
Fax: +(52 5)70-2985

Puerto Rico

Honeywell Inc.
Phone: +(809)792-7075
Fax: +(809)792-0053

Venezuela

Honeywell CA
Phone: +(58 2)238-0211
Fax: +(58 2)238-3391

Sensing & Control

Honeywell Korea.
191, Hangangro-2 Ga, Yongsan-Gu
Seoul 140-702 Korea
www.honeywell.com/sensing
email: S&C_AP@singapore.honeywell.com



Printed with Soy Ink
on 50% Recycled Paper